

Ram 1500 2019 -

TG/TS 6R19

INSTALLATION ASSISTANCE

If any installation hardware is missing or lost, or you have any problems or questions during the installation of your new Hood Protector, please contact the manufacturer for assistance. Do not contact your retailer.

ASISTENCIA DE INSTALACIÓN

Si alguna pieza de instalación esta faltante o perdida, o tiene algún problema o pregunta durante la instalación de su nuevo protector, por favor contacte el fabricante para asistencia. No contacte su vendedor.

ASSISTANCE D'INSTALLATION

Si le matériel d'installation est manquant ou perdu, ou si vous avez des problèmes ou des questions lors de l'installation de votre nouveau protecteur de capot, veuillez contacter le fabricant pour obtenir de l'aide. Ne contactez pas votre revendeur.

1-833-801-4080
www.formfithoodprotectors.com
customer@formfithoodprotectors.com



WARRANTY REGISTRATION

After completing the installation of your new Hood Protector, please contact the manufacturer to register your warranty. This validates your warranty in the event you have any future concerns with your Hood Protector.

GARANTÍA DE REGISTRACIÓN

Después de completada la instalación de su nuevo protector, por favor contacte su minorista para registrar su garantía. Esto valida su garantía en caso de que tenga una preocupación futura con su protector.

ENREGISTREMENT DE GARANTIE

Après avoir terminé l'installation de votre nouveau protecteur de capot, veuillez contacter le fabricant pour enregistrer votre garantie. Ceci valide votre garantie dans le cas où vous auriez des soucis avec votre capot de protection.

<https://www.formfithoodprotectors.com/warranty-registration/>

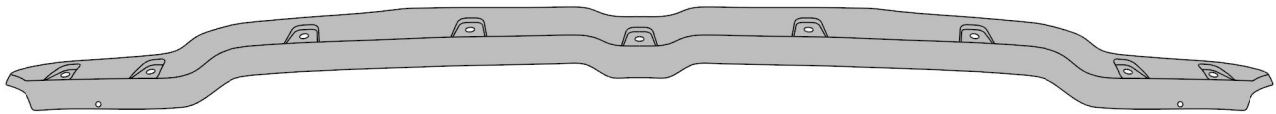

A 1x



B 2x

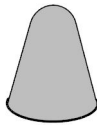

C 4x

48" XL



D 1x

1.5" x 1.5"



38mm x 38mm

O 3x

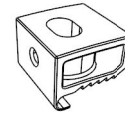

F 3x



G 3x



H 3x

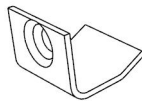

I 3x

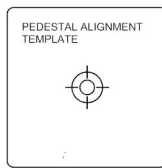

J 1x

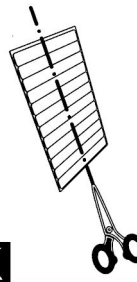

K 1x

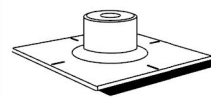

L 9x



M 9x



N 9x

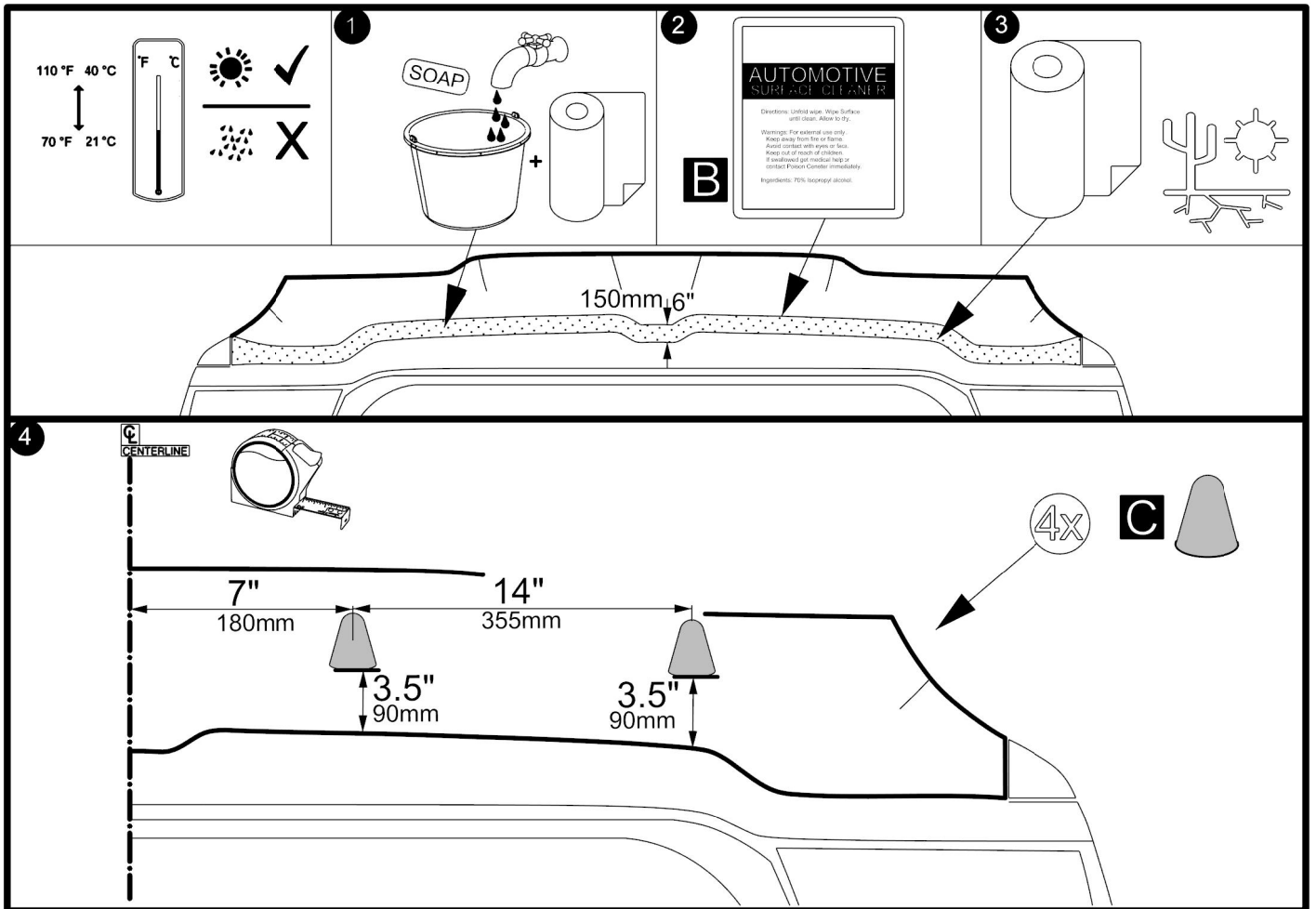
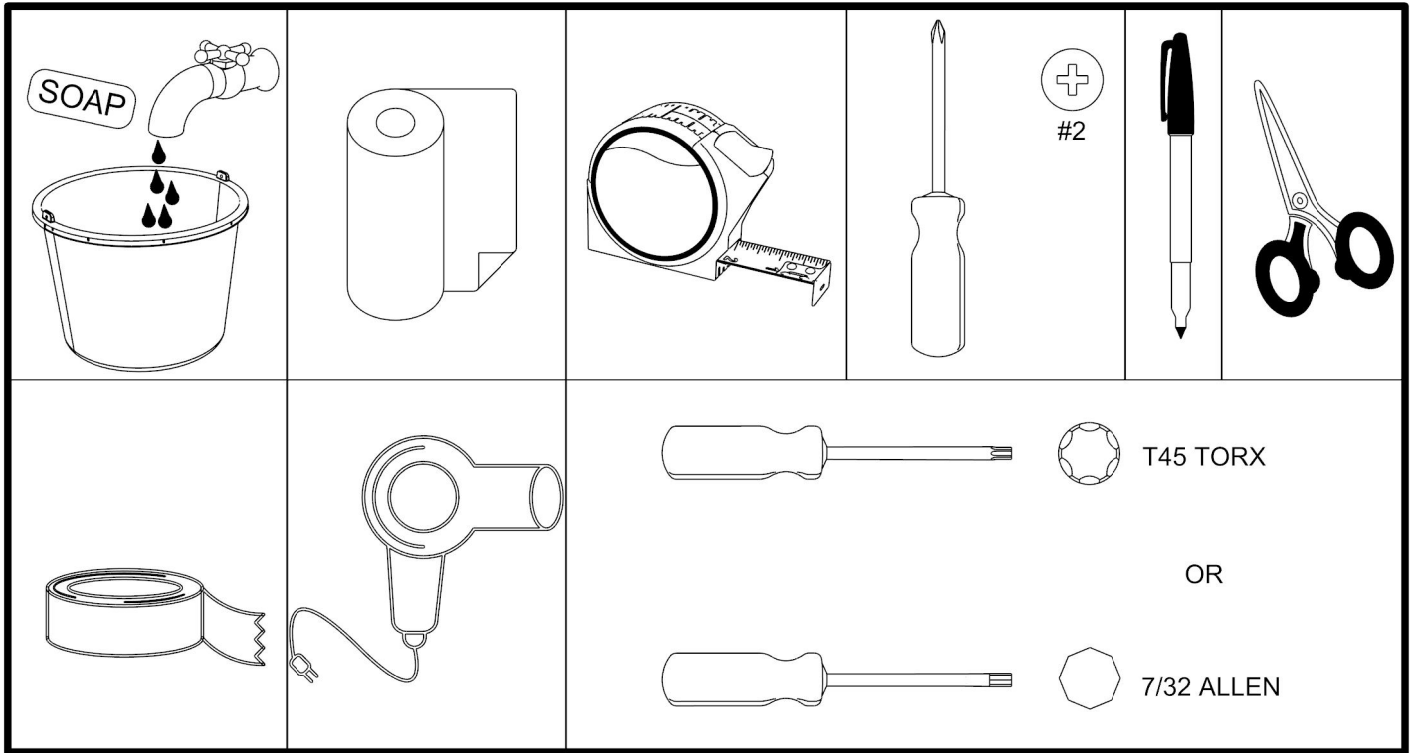

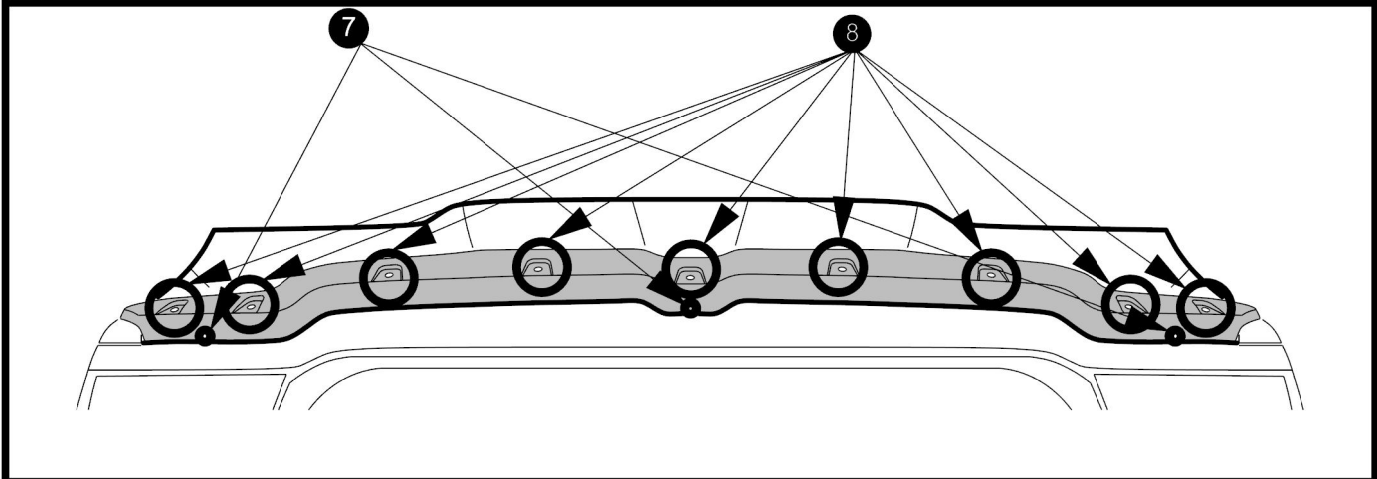
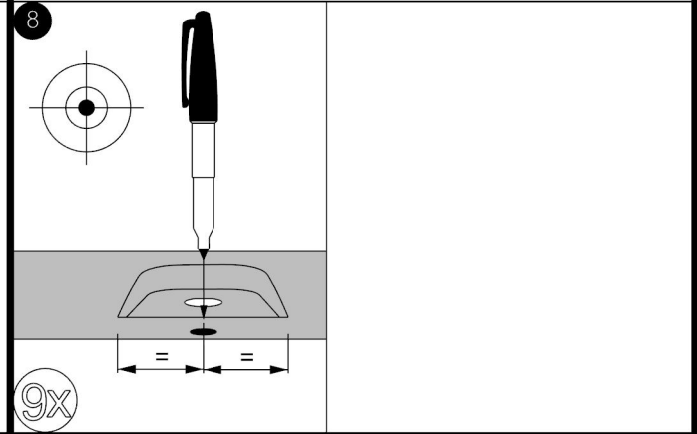
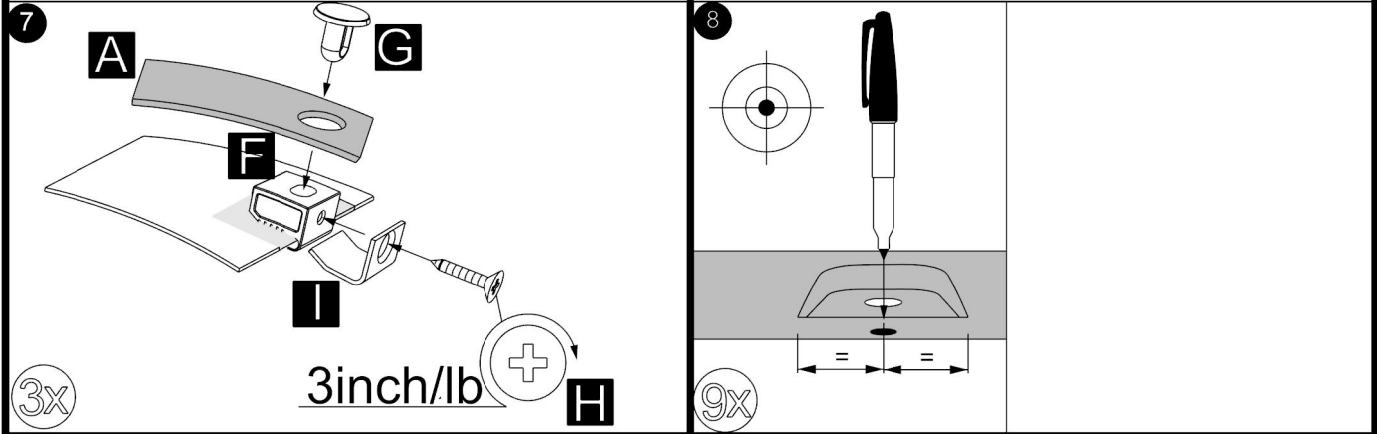
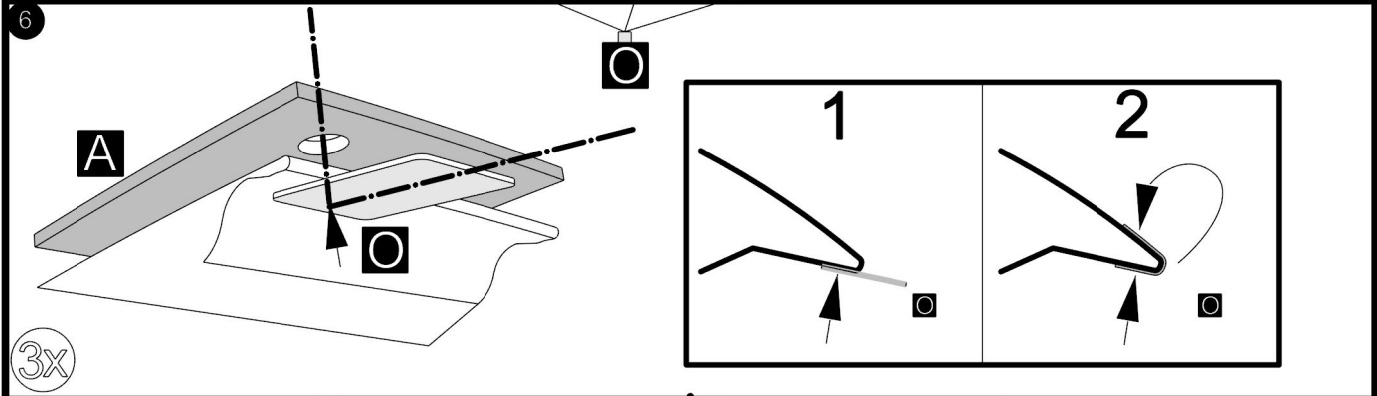
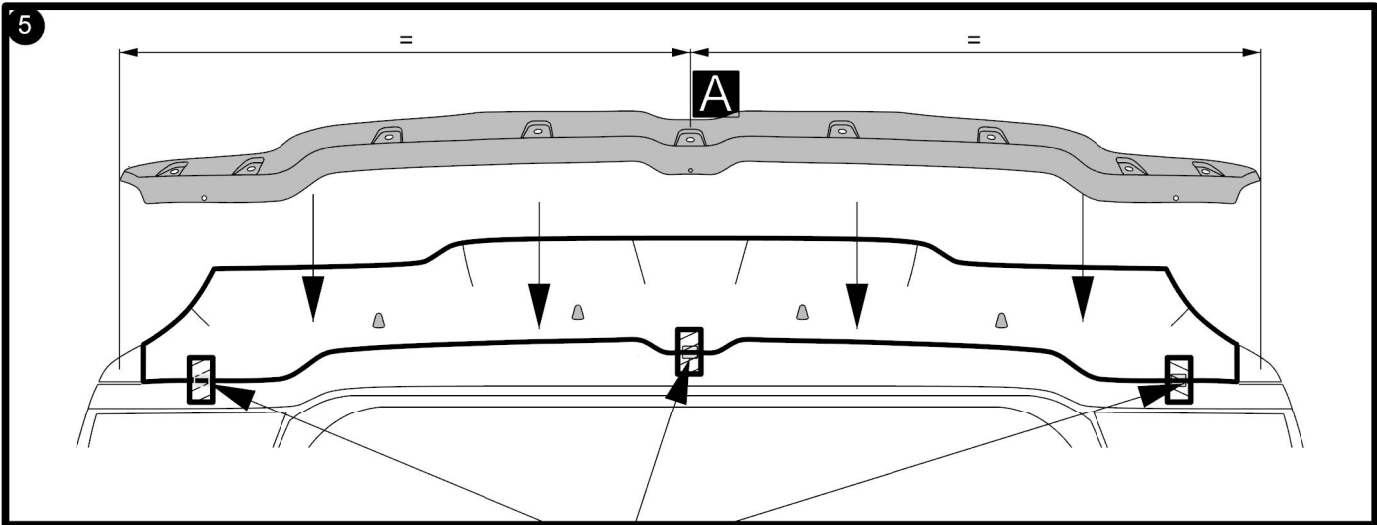

9

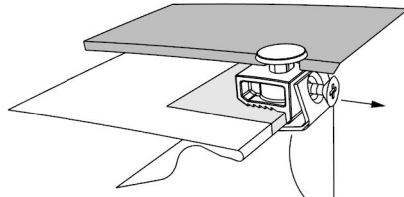

3x loosen  **H**

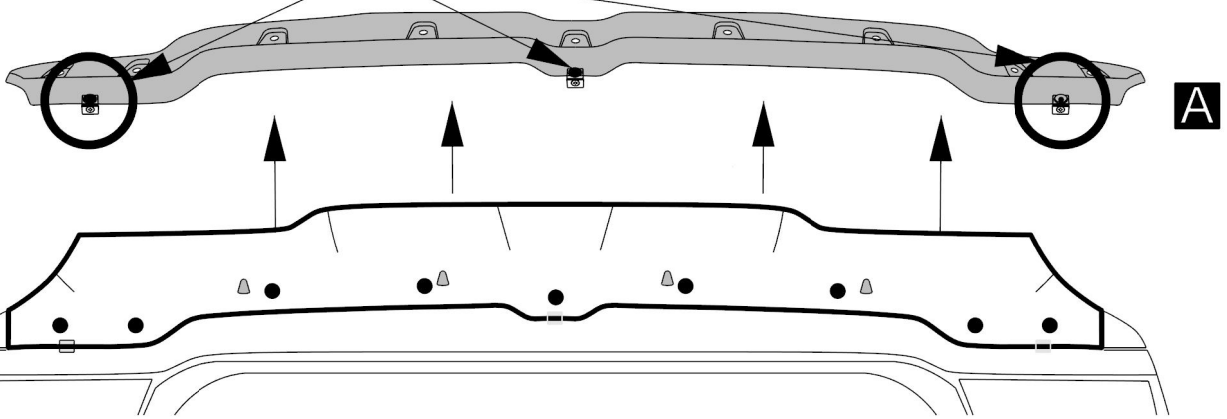

10

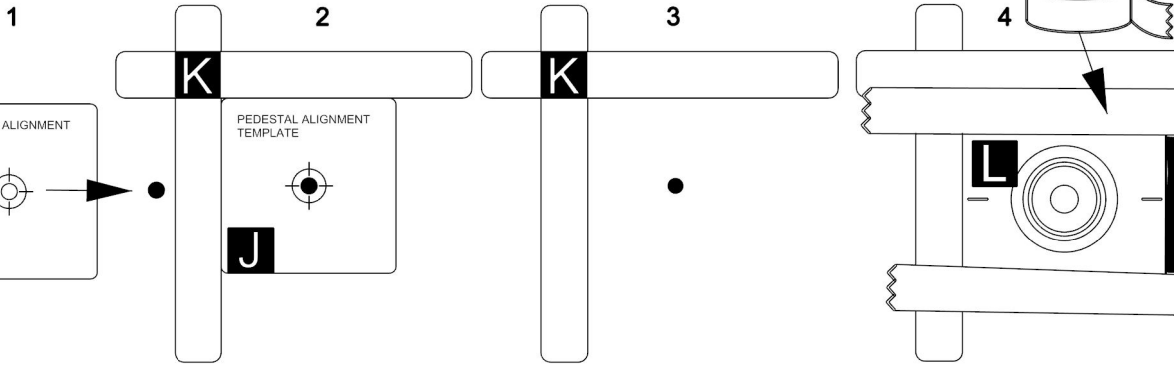

9x

11

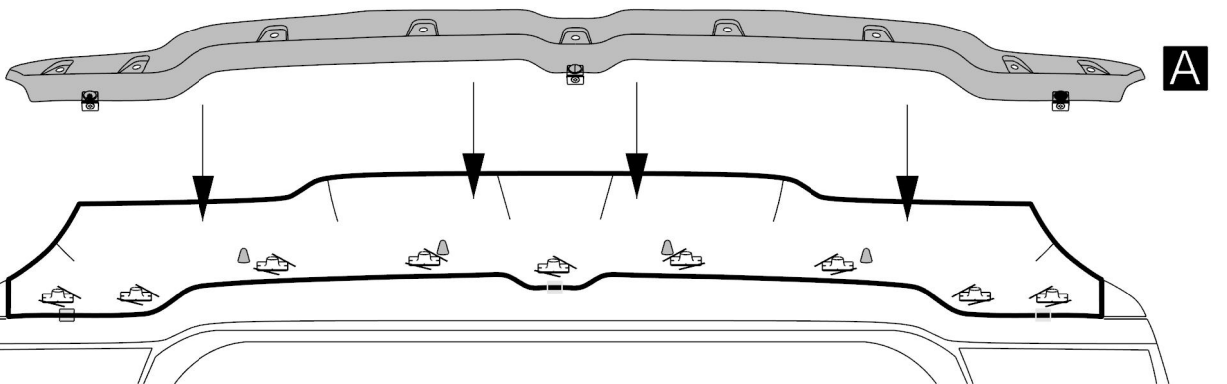

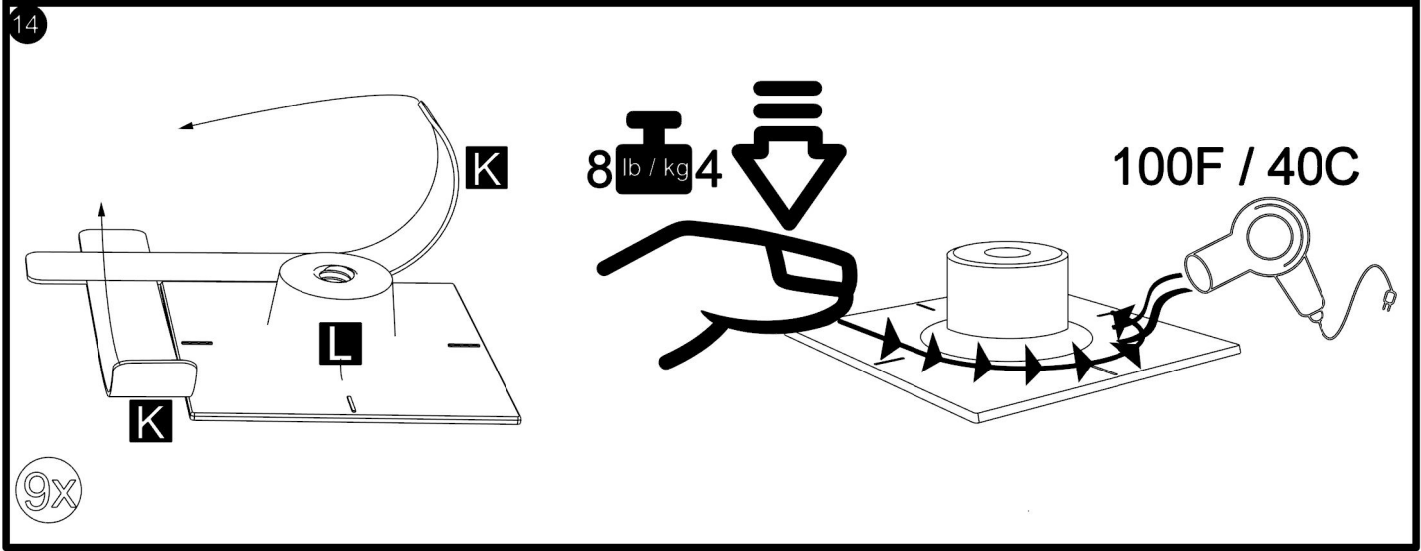
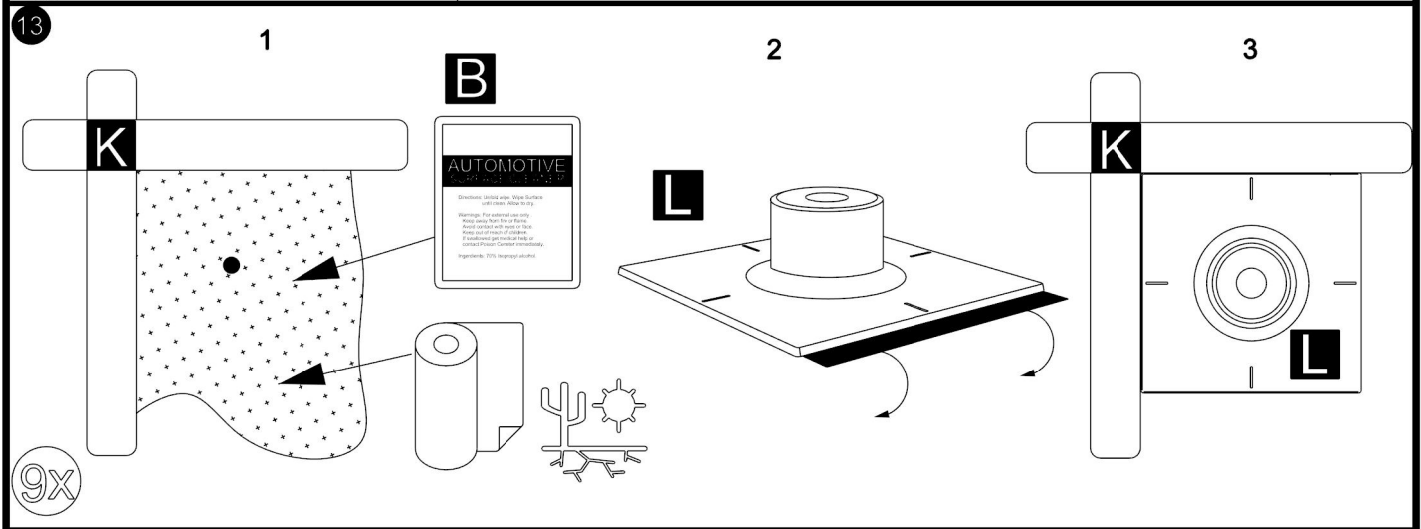
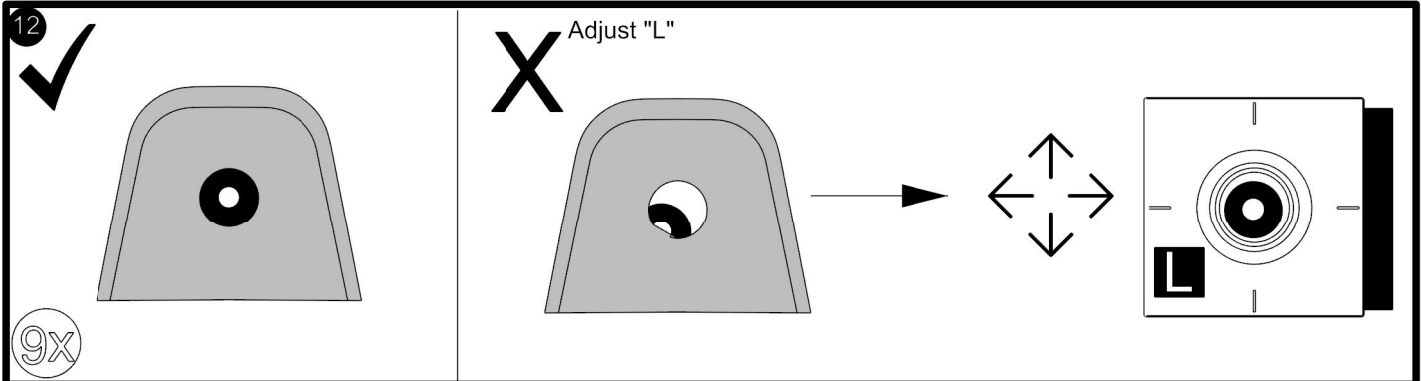

15

D

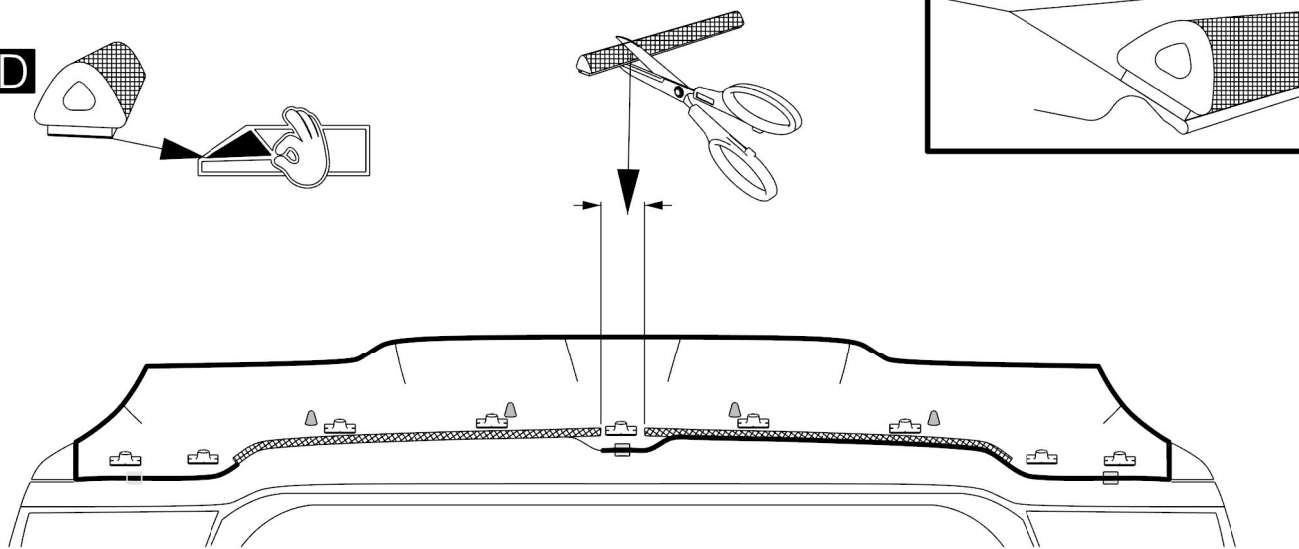

16

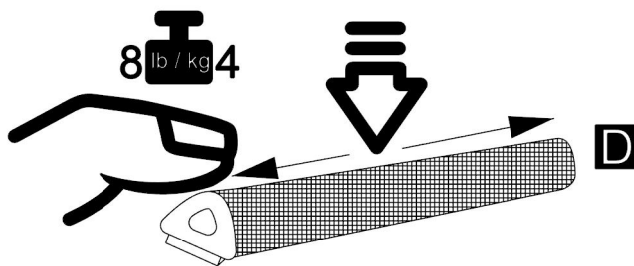

17

